

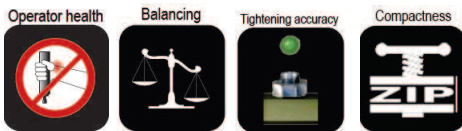

Carbon telescoping arms

DMF/DMFI Series



DMF Series : Erase your torque reaction until 300 Nm.

- **Comfort** : Easy to install on moving assembly line (mountable on existing standard rail). Require little space and doesn't disrupt flow production. Erase torque reaction of power tools.
- **Economy** : Maintenance free thanks to the carbon fiber (no greasing). Long last of living thanks to the durable carbon fiber.
- **Productivity** : Easy and quick operator handling thanks to the light weight carbon fiber.

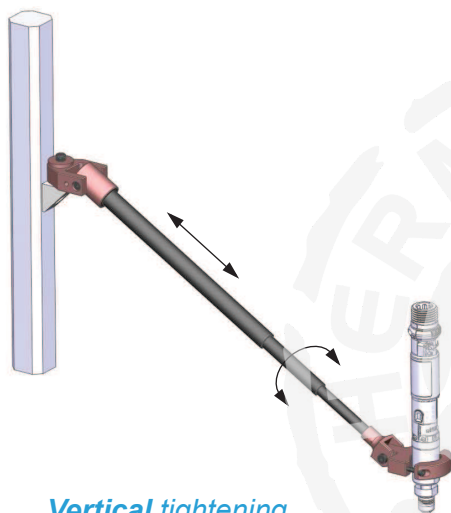

Vertical tightening



Frontal tightening

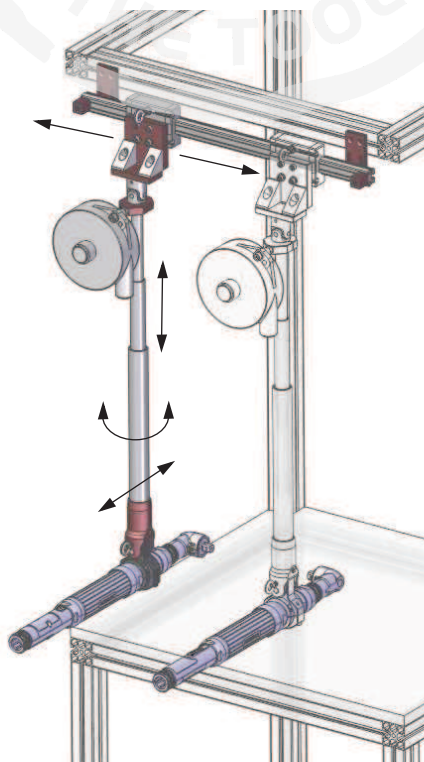

Side tightening

Articulated pantograph

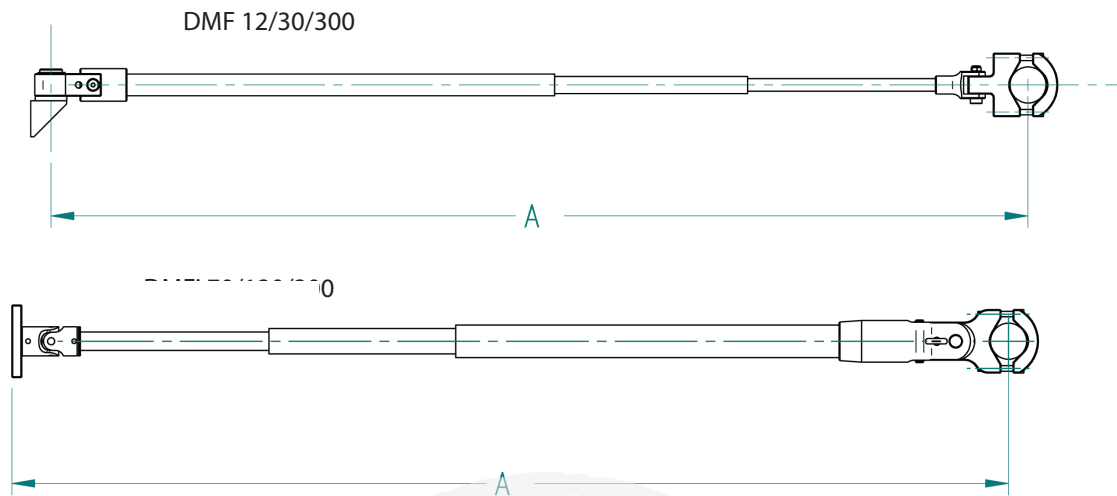

Standard stroke

Model	Max torque (Nm)	Standard clamp	Tool Ø (mm)	A min (mm)	A max (mm)	Code	
						Without clamp	With clamp
DMF 5/950	5	P1	25 - 42	460	950		4-1200445
DMF 12/950	12	P1	25 - 50	460	950		4-1201004
DMF 12/1500	12	P1	25 - 50	650	1500		4-1201005
DMF 12/2000	12	P1	25 - 50	820	2000		4-1201006
DMF 30/960	30	P1	28 - 52	475	960	4-1244000	4-1200074
DMF 30/1500	30	P1	28 - 52	656	1500	4-1244001	4-1200282
DMF 30/2000	30	P1	28 - 52	823	2000	4-1244002	4-1200283
DMF 30/2500	30	P1	28 - 52	993	2500	4-1244003	4-1200284
DMF 30/3000	30	P1	28 - 52	1321	3000	4-1200813	4-1200818
DMFi 70/1500	70	P2	35 - 52	667	1500	4-1244004	4-1244020
DMFi 70/2000	70	P2	35 - 52	833	2000	4-1244005	4-1244021
DMFi 70/2500	70	P2	35 - 52	1000	2500	4-1244006	4-1244022
DMFi 70/3000	70	P2	35 - 52	1330	3000	4-1200814	4-1200819
DMFi 120/1500	120	P2	35 - 52	691	1500	4-1244007	4-1244023
DMFi 120/2000	120	P2	35 - 52	857	2000	4-1244008	4-1244024
DMFi 120/2500	120	P2	35 - 52	1023	2500	4-1244009	4-1244025
DMFi 120/3000	120	P2	35 - 52	1347	3000	4-1200815	4-1200820
DMFi 200/1500	200	P2	Maxi 63	920	1500	4-1244050	4-1244026
DMFi 200/2000	200	P2	Maxi 63	1170	2000	4-1244051	4-1244027
DMFi 200/2500	200	P2	Maxi 63	1420	2500	4-1244052	4-1244028
DMFi 200/3000	200	P2	Maxi 63	1720	3000	4-1200816	4-1200821
DMF 300/1500	300	P2	Maxi 73	970	1500	4-1244053	4-1244029
DMF 300/2000	300	P2	Maxi 73	1220	2000	4-1244054	4-1244030
DMF 300/2500	300	P2	Maxi 73	1470	2500	4-1244055	4-1244031
DMF 300/3000	300	P2	Maxi 73	1800	3000	4-1200817	4-1200822

Other dimensions on request (max length 4 meters).
Torque up to 600 Nm is available on request.

Long stroke (LS)

Model	Max torque (Nm)	Standard clamp	Tool Ø (mm)	A min (mm)	A max (mm)	Code	
						Without clamp	With clamp
DMF 30/1500 LS	30	P1	28 - 52	555	1500	4-1200852	4-1200855
DMF 30/2000 LS	30	P1	28 - 52	680	2000	4-1200853	4-1200856
DMF 30/2500 LS	30	P1	28 - 52	805	2500	4-1200854	4-1200857
DMFi 100/1500 LS	100	P2	35 - 52	592	1500	4-1201213	4-1201221
DMFi 100/2000 LS	100	P2	35 - 52	717	2000	4-1201214	4-1201222
DMFi 100/2500 LS	100	P2	35 - 52	842	2500	4-1201215	4-1201223
DMFi 200/1500 LS	200	P2	Maxi 63	728	1500	4-1201216	4-1201224
DMFi 200/2000 LS	200	P2	Maxi 63	894	2000	4-1201217	4-1201225
DMFi 200/2500 LS	200	P2	Maxi 63	1060	2500	4-1201220	4-1201226



Vertical tightening

DMF/DMFI Series

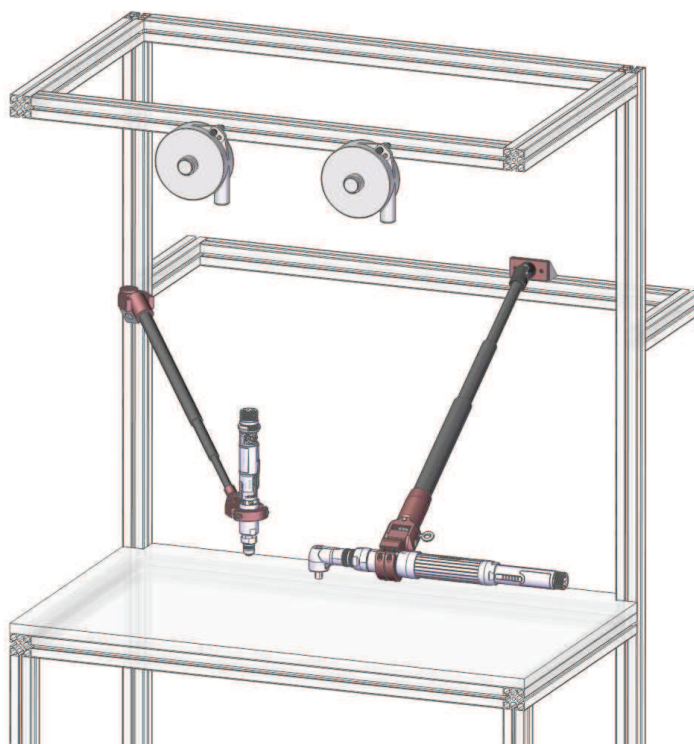

P1 clamp

For	Clamping	Code
DMF12	Clamp 25/50	Standard
DMF30	Clamp 28/52	Standard
DMFi 70	Mounting plate interface	4-1244032
DMFi 120/200	Mounting plate interface	4-1244033

P2 clamp

For	Capacity	Code
DMF30	28/52	4-1200300
DMFi70	35/52	Standard
DMFi120/200	35/52	Standard
DMFi200	63	Standard
DMF300	73	Standard

Quick release clamp

For	Type	Code
DMF12	P1	4-1201003
DMF30	P1	4-1200017
DMFi 70	P2	4-1283102
DMFi 120/200	P2	4-1283103

Quick release interface

For	Code
DMF12	4-1200470
DMF30	4-1200471
DMF70	4-1283100
DMF120/200	4-1283101

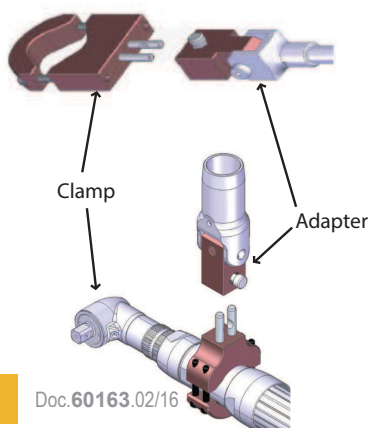
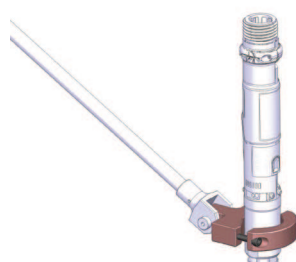

Frontal tightening

DMF/DMFI Series

Fixed mounting

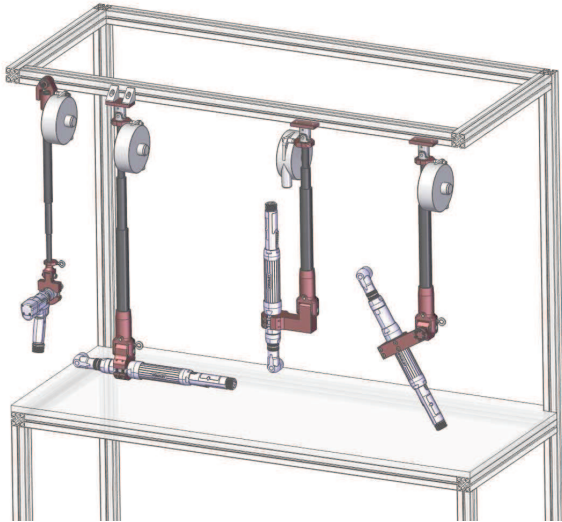

Mounting on rail with locker

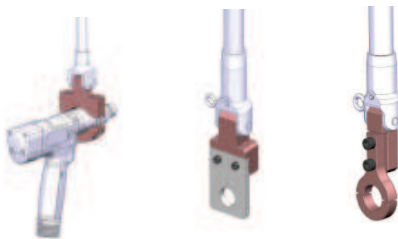
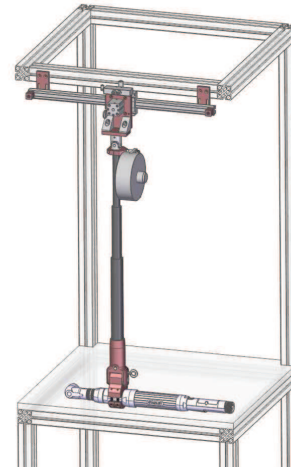

P1 clamp

For	Clamping	Code
DMF12	Clamp 25/50	Standard
DMF30	Clamp 28/52	Standard
DMFi70	Mounting plate interface	4-1244032
DMFi120/200	Mounting plate interface	4-1244033
DMF300	Mounting plate interface	On request

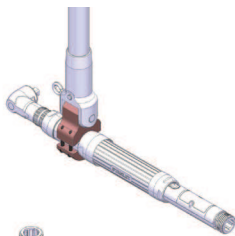

P2 clamp

For	Tool Ø	Code
DMF30	28/52	4-1200300
DMFi70	35/52	Standard
DMFi120/200	35/52	Standard
DMFi200	Max 63	Standard
DMF300	Max 73	Standard

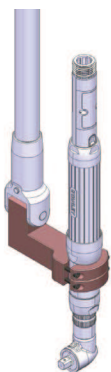

P4 clamp

For	Tool Ø	Code
DMF30	28/52	4-1200302
DMFi70	35/52	4-1244015
DMFi120/200	35/52	4-1244016
DMFi200	Max 63	4-1244058
DMF300	Max 73	4-1244059



Tilt interface

For	Tool Ø	Code
Interface/DMF30 (for all clamp types)	-	30° 45° 4-1201140 4-1201141

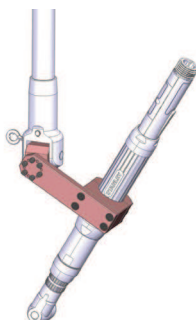

Swivel clamp

For	Tool Ø	Code
DMFi70 P2/P4	35/52	4-1201137
DMFi120/200 P2/P4	35/52	4-1201138
DMFi200 P2/P4	Max 63	4-1201139
DMF300	Max 73	On request



Side tightening

DMF/DMFI Series

Fixed mounting

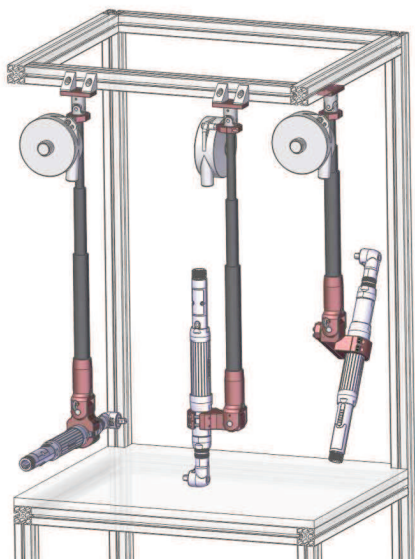

Mounting on rail

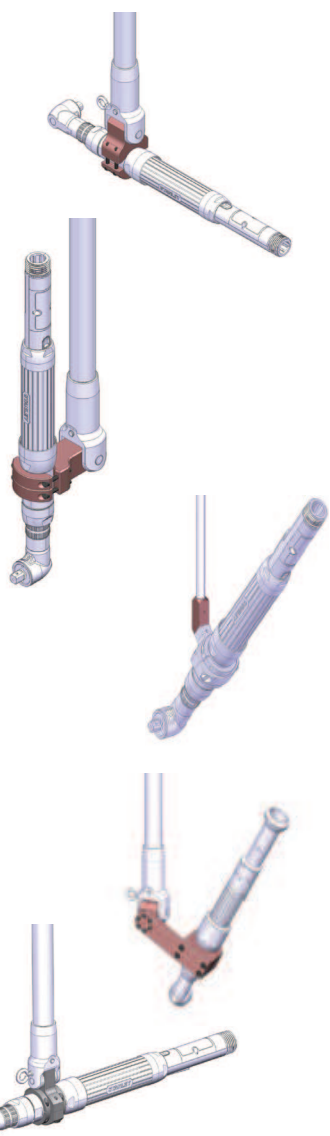
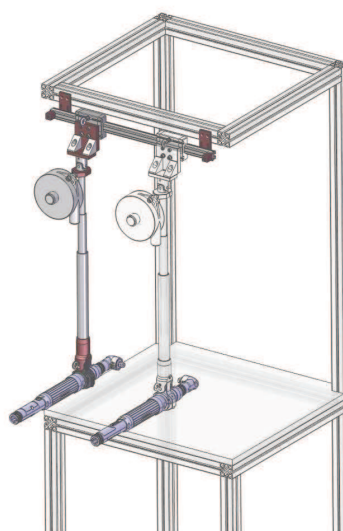

P2 Clamp

For	Tool Ø	Code
DMF30	28/52	4-1200300
DMFi70	35/52	Standard
DMFi120/200	35/52	Standard
DMFi200	Max 63	Standard
DMF300	Max 73	Standard

P3 Clamp

For	Tool Ø	Code
DMF30	28/52	4-1200301
DMFi70	35/52	4-1244013
DMFi120/200	35/52	4-1244014
DMFi200	Max 63	4-1244056
DMF300	Max 73	4-1244057

Tilt interface

For	Tool Ø	Code
Interface / DMF30	-	30° 45° 4-1201140 4-1201141

Swivel clamp

For	Tool Ø	Code
DMFi70	35/52	4-1201137
DMFi120/200	35/52	4-1201138
DMFi200	Max 63	4-1201139
DMF300	Max 73	On request

Rotating clamp

For	Tool Ø	Code
DMF30	On request	4-1201134
DMFi70	On request	4-1244034
DMFi120/200	On request	4-1244035
DMFi200	On request	4-1244060
DMF300	On request	4-1201136

DMF/DMFi

Mounting on rail

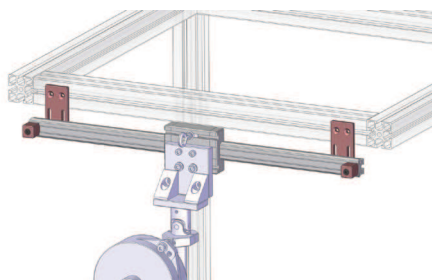

Rails

Length	Stroke	Number of flanges	Code
600	450	2	4-1200132
800	650	2	4-1200160
1000	850	2	4-1200161
1200	1050	3	4-1200162
1500	1350	3	4-1200163
2000	1850	4	4-1200164

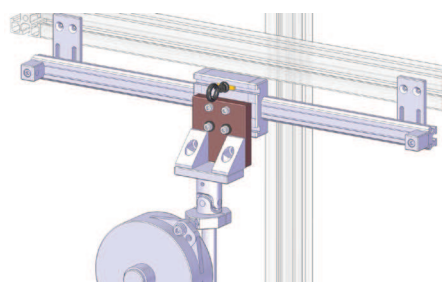

Rail interface

Allows installation of DMF on rail.

For	Code
DMF12/30	4-1200341
DMFi70/120/200	4-1200708
DMF300	4-1200342

NOTE : delivered without safety hook (Code 4-1200309)

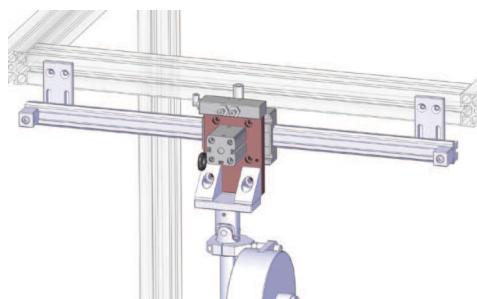

Pneumatic locker

For	Type	Code
DMF12/30	Pneumatic	4-1200442
DMF12/30	Electric	4-1200869
DMFi70/120	Pneumatic	4-1200706
DMFi70/120	Electric	4-1200707
DMFi200	Electric	4-1201150
DMF300	Electric	4-1201142

The power tool has to be equipped with a motor run signal.

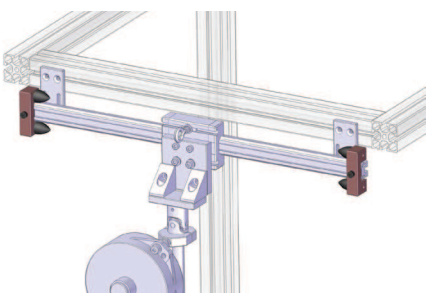

Absorbing stop

Recommended in case of repeatable side shocks.

Code 4-1201121 Set of 2

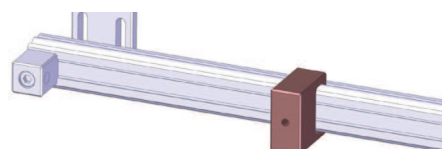

Adjustable stop

To limit the slide of the arm on the rail.

Code 4-1200167

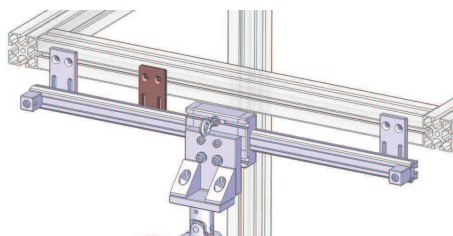

Additional flange

To reinforce the rail installation for high torque applications.

Code 4-1200873



Accessories DMF/DMFi

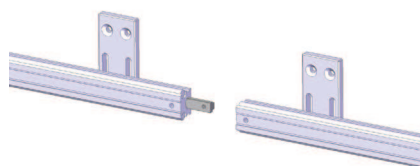

Rail link

To link two rails together.

Code 4-1200307

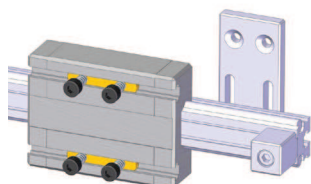

Single trolley

To mount additional tools on the same rail.

- Single trolley Code 4-1200165

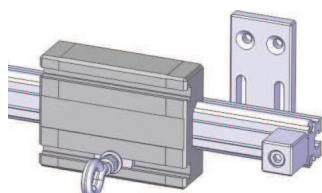

- Trolley for additional balancer Code 4-1200166

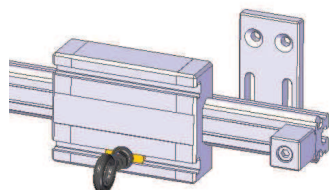

Additional safety hook

To secure balancer.

Code 4-1200309

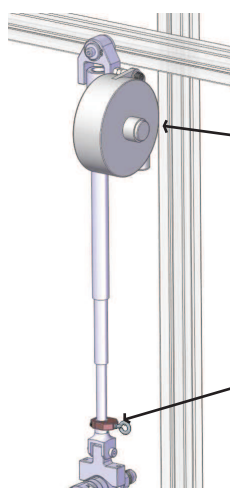

Balancing kit for DMF 12/30/300

For	Tool (Kg)	Code
DMF12	1 to 2	4-1200303
DMF30	1 to 2,5	4-1200304
DMF30	2 to 4	4-1200305
DMF300	4 to 8	4-1200704
DMF300	6 to 10	4-1200705

Balancer attachment kit for DMF30 Code 4-1201143

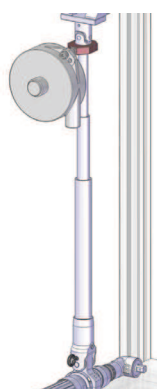

Balancing kit for DMFi 70/120/200

For	Capacity (Kg)	Code
DMFi 70/120/200	2 - 4	4-1200701
DMFi 70/120/200	4 - 6	4-1200702
DMFi 70/120/200	6 - 8	4-1200703

Delivered with balancer attachment kit.

Special arms on request

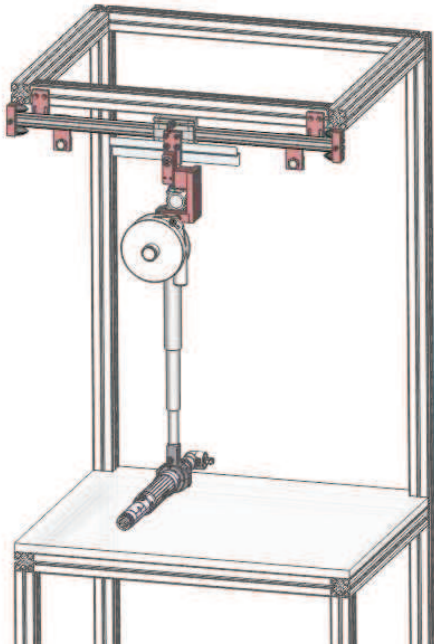

DMF...PC + horizontal rail with

Additional presence sensors on the rail allow identification of two working zones (right and left). Contact us for more information.



DMF 300 with rotative clamp and balancing kit



DMFi 200 with remote start handle



DMFi 600 with air locker + special tool holder for pistol tool